

Features

- Output current to 0.5 A
- Output voltages of 5; 6; 8; 9; 10; 12; 15; 24 V
- Thermal overload protection
- Short circuit protection
- Output transition SOA protection
- $\pm 2\%$ output voltage tolerance
- Guaranteed in extended temperature range



Description

The L78MxxA series of three-terminal positive regulators is available in DPAK packages and with several fixed output voltages, making it useful in a wide range of applications. These regulators can provide local on-card regulation eliminating the distribution problems associated with single point regulation. Each type employs internal current limiting, thermal shutdown and safe area protection, making it essentially indestructible. If adequate heat sinking is provided, they can deliver over 0.5 A output current. Although designed primarily as fixed voltage regulators, these devices can be used with external components to obtain adjustable voltage and currents.

Figure 1. Block diagram

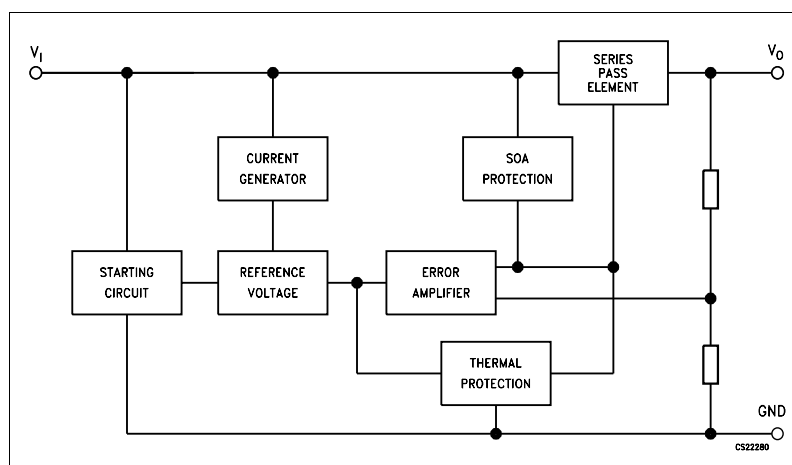

3 Maximum ratings

Table 2. Absolute maximum ratings

Symbol	Parameter		Value	Unit
V_I	DC input voltage	for $V_O = 5$ to 18 V	35	V
		for $V_O = 20, 24$ V	40	
I_O	Output current		Internally limited	mA
P_D	Power dissipation		Internally limited	mW
T_{STG}	Storage temperature range		-65 to 150	°C
T_{OP}	Operating junction temperature range	for L78M00AC	0 to 125	°C
		for L78M00AB	-40 to 125	

Note: Absolute maximum ratings are those values beyond which damage to the device may occur. Functional operation under these condition is not implied.

Table 3. Thermal data

Symbol	Parameter	DPAK	Unit
R_{thJC}	Thermal resistance junction-case	8	°C/W
R_{thJA}	Thermal resistance junction-ambient	100	°C/W

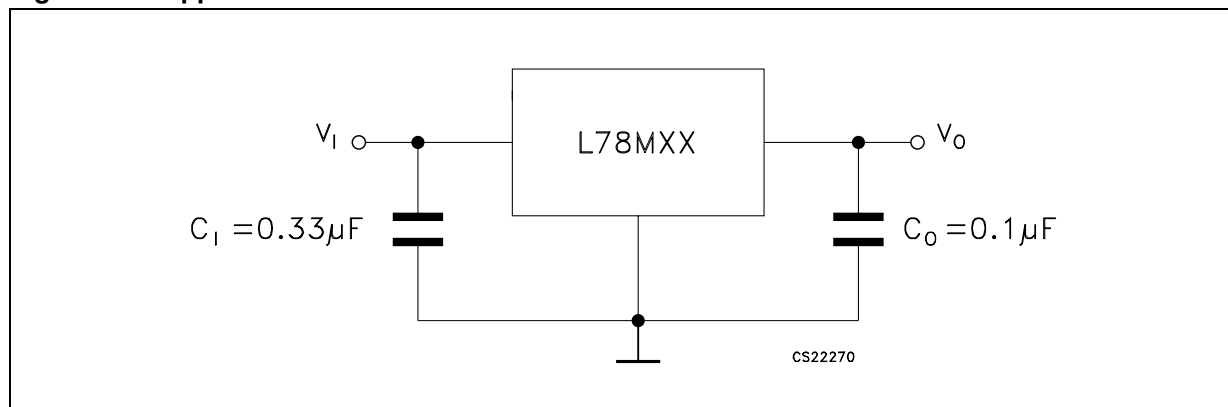
Figure 4. Application circuit

5 Electrical characteristics

Table 4. Electrical characteristics of 78M05

Refer to the test circuits, $V_I = 10\text{ V}$, $I_O = 350\text{ mA}$, $C_I = 0.33\text{ }\mu\text{F}$, $C_O = 0.1\text{ }\mu\text{F}$, $T_J = -40\text{ to }125\text{ }^\circ\text{C}$ (AB), $T_J = 0\text{ to }125\text{ }^\circ\text{C}$ (AC) unless otherwise specified.

Symbol	Parameter	Test conditions	Min.	Typ.	Max.	Unit
V_O	Output voltage	$T_J = 25^\circ\text{C}$	4.9	5	5.1	V
V_O	Output voltage	$I_O = 5\text{ to }350\text{ mA}$, $V_I = 7\text{ to }20\text{ V}$	4.8	5	5.2	V
ΔV_O	Line regulation	$V_I = 7\text{ to }25\text{ V}$, $I_O = 200\text{ mA}$, $T_J = 25^\circ\text{C}$			100	mV
		$V_I = 8\text{ to }25\text{ V}$, $I_O = 200\text{ mA}$, $T_J = 25^\circ\text{C}$			50	
ΔV_O	Load regulation	$I_O = 5\text{ to }500\text{ mA}$, $T_J = 25^\circ\text{C}$			100	mV
		$I_O = 5\text{ to }200\text{ mA}$, $T_J = 25^\circ\text{C}$			50	
I_d	Quiescent current	$T_J = 25^\circ\text{C}$			6	mA
ΔI_d	Quiescent current change	$I_O = 5\text{ to }350\text{ mA}$			0.5	mA
		$I_O = 200\text{ mA}$, $V_I = 8\text{ to }25\text{ V}$			0.8	
$\Delta V_O/\Delta T$	Output voltage drift	$I_O = 5\text{ mA}$		-0.5		mV/ $^\circ\text{C}$
SVR	Supply voltage rejection	$V_I = 8\text{ to }18\text{ V}$, $f = 120\text{ Hz}$, $I_O = 300\text{ mA}$, $T_J = 25^\circ\text{C}$	62			dB
eN	Output noise voltage	$B = 10\text{ Hz to }100\text{ kHz}$, $T_J = 25^\circ\text{C}$		40		μV
V_d	Dropout voltage	$T_J = 25^\circ\text{C}$		2		V
I_{sc}	Short circuit current	$T_J = 25^\circ\text{C}$, $V_I = 35\text{ V}$		300		mA
I_{scp}	Short circuit peak current	$T_J = 25^\circ\text{C}$		700		mA

Table 5. Electrical characteristics of 78M06

Refer to the test circuits, $V_I = 11\text{ V}$, $I_O = 350\text{ mA}$, $C_I = 0.33\text{ }\mu\text{F}$, $C_O = 0.1\text{ }\mu\text{F}$, $T_J = -40\text{ to }125\text{ }^\circ\text{C}$ (AB), $T_J = 0\text{ to }125\text{ }^\circ\text{C}$ (AC) unless otherwise specified.

Symbol	Parameter	Test conditions	Min.	Typ.	Max.	Unit
V_O	Output voltage	$T_J = 25^\circ\text{C}$	5.88	6	6.12	V
V_O	Output voltage	$I_O = 5\text{ to }350\text{ mA}$, $V_I = 8\text{ to }21\text{ V}$	5.75	6	6.3	V
ΔV_O	Line regulation	$V_I = 8\text{ to }25\text{ V}$, $I_O = 200\text{ mA}$, $T_J = 25^\circ\text{C}$			100	mV
		$V_I = 9\text{ to }25\text{ V}$, $I_O = 200\text{ mA}$, $T_J = 25^\circ\text{C}$			30	
ΔV_O	Load regulation	$I_O = 5\text{ to }500\text{ mA}$, $T_J = 25^\circ\text{C}$			120	mV
		$I_O = 5\text{ to }200\text{ mA}$, $T_J = 25^\circ\text{C}$			60	
I_d	Quiescent current	$T_J = 25^\circ\text{C}$			6	mA
ΔI_d	Quiescent current change	$I_O = 5\text{ to }350\text{ mA}$			0.5	mA
		$I_O = 200\text{ mA}$, $V_I = 9\text{ to }25\text{ V}$			0.8	
$\Delta V_O/\Delta T$	Output voltage drift	$I_O = 5\text{ mA}$		-0.5		mV/ $^\circ\text{C}$
SVR	Supply voltage rejection	$V_I = 9\text{ to }19\text{ V}$, $f = 120\text{ Hz}$, $I_O = 300\text{ mA}$, $T_J = 25^\circ\text{C}$	59			dB
eN	Output noise voltage	$B = 10\text{ Hz to }100\text{ kHz}$		45		μV
V_d	Dropout voltage	$T_J = 25^\circ\text{C}$		2		V
I_{sc}	Short circuit current	$T_J = 25^\circ\text{C}$, $V_I = 35\text{ V}$		270		mA
I_{scp}	Short circuit peak current	$T_J = 25^\circ\text{C}$		700		mA

Table 6. Electrical characteristics of 78M08

Refer to the test circuits, $V_I = 14\text{ V}$, $I_O = 350\text{ mA}$, $C_I = 0.33\text{ }\mu\text{F}$, $C_O = 0.1\text{ }\mu\text{F}$, $T_J = -40\text{ to }125\text{ }^\circ\text{C}$ (AB), $T = 0\text{ to }125\text{ }^\circ\text{C}$ (AC) unless otherwise specified).

Symbol	Parameter	Test conditions	Min.	Typ.	Max.	Unit
V_O	Output voltage	$T_J = 25^\circ\text{C}$	7.84	8	8.16	V
V_O	Output voltage	$I_O = 5\text{ to }350\text{ mA}$, $V_I = 10.5\text{ to }23\text{ V}$	7.7	8	8.3	V
ΔV_O	Line regulation	$V_I = 10.5\text{ to }25\text{ V}$, $I_O = 200\text{ mA}$, $T_J = 25^\circ\text{C}$			100	mV
		$V_I = 11\text{ to }25\text{ V}$, $I_O = 200\text{ mA}$, $T_J = 25^\circ\text{C}$			30	
ΔV_O	Load regulation	$I_O = 5\text{ to }500\text{ mA}$, $T_J = 25^\circ\text{C}$			160	mV
		$I_O = 5\text{ to }200\text{ mA}$, $T_J = 25^\circ\text{C}$			80	
I_d	Quiescent current	$T_J = 25^\circ\text{C}$			6	mA
ΔI_d	Quiescent current change	$I_O = 5\text{ to }350\text{ mA}$			0.5	mA
		$I_O = 200\text{ mA}$, $V_I = 10.5\text{ to }25\text{ V}$			0.8	
$\Delta V_O/\Delta T$	Output voltage drift	$I_O = 5\text{ mA}$		-0.5		mV/ $^\circ\text{C}$
SVR	Supply voltage rejection	$V_I = 11.5\text{ to }21.5\text{ V}$, $f = 120\text{ Hz}$ $I_O = 300\text{ mA}$, $T_J = 25^\circ\text{C}$	56			dB
eN	Output noise voltage	$B = 10\text{ Hz to }100\text{ kHz}$, $T_J = 25^\circ\text{C}$		52		μV
V_d	Dropout voltage	$T_J = 25^\circ\text{C}$		2		V
I_{sc}	Short circuit current	$T_J = 25^\circ\text{C}$, $V_I = 35\text{ V}$		250		mA
I_{scp}	Short circuit peak current	$T_J = 25^\circ\text{C}$		700		mA

Table 7. Electrical characteristics of 78M09

Refer to the test circuits, $V_I = 15\text{ V}$, $I_O = 350\text{ mA}$, $C_I = 0.33\text{ }\mu\text{F}$, $C_O = 0.1\text{ }\mu\text{F}$, $T_J = -40\text{ to }125\text{ }^\circ\text{C}$ (AB), $T_J = 0\text{ to }125\text{ }^\circ\text{C}$ (AC) unless otherwise specified).

Symbol	Parameter	Test conditions	Min.	Typ.	Max.	Unit
V_O	Output voltage	$T_J = 25^\circ\text{C}$	8.82	9	9.18	V
V_O	Output voltage	$I_O = 5\text{ to }350\text{ mA}$, $V_I = 11.5\text{ to }24\text{ V}$	8.64	9	9.36	V
ΔV_O	Line regulation	$V_I = 11.5\text{ to }25\text{ V}$, $I_O = 200\text{ mA}$, $T_J = 25^\circ\text{C}$			100	mV
		$V_I = 12\text{ to }25\text{ V}$, $I_O = 200\text{ mA}$, $T_J = 25^\circ\text{C}$			30	
ΔV_O	Load regulation	$I_O = 5\text{ to }500\text{ mA}$, $T_J = 25^\circ\text{C}$			180	mV
		$I_O = 5\text{ to }200\text{ mA}$, $T_J = 25^\circ\text{C}$			90	
I_d	Quiescent current	$T_J = 25^\circ\text{C}$			6	mA
ΔI_d	Quiescent current change	$I_O = 5\text{ to }350\text{ mA}$			0.5	mA
		$I_O = 200\text{ mA}$, $V_I = 11.5\text{ to }25\text{ V}$			0.8	
$\Delta V_O/\Delta T$	Output voltage drift	$I_O = 5\text{ mA}$		-0.5		mV/ $^\circ\text{C}$
SVR	Supply voltage rejection	$V_I = 12.5\text{ to }23\text{ V}$, $f = 120\text{ Hz}$, $I_O = 300\text{ mA}$, $T_J = 25^\circ\text{C}$	56			dB
eN	Output noise voltage	$B = 10\text{ Hz to }100\text{ kHz}$, $T_J = 25^\circ\text{C}$		52		μV
V_d	Dropout voltage	$T_J = 25^\circ\text{C}$		2		V
I_{sc}	Short circuit current	$V_I = 35\text{ V}$, $T_J = 25^\circ\text{C}$		250		mA
I_{scp}	Short circuit peak current	$T_J = 25^\circ\text{C}$		700		mA

Table 8. Electrical characteristics of 78M10

Refer to the test circuits, $V_I = 16\text{ V}$, $I_O = 350\text{ mA}$, $C_I = 0.33\text{ }\mu\text{F}$, $C_O = 0.1\text{ }\mu\text{F}$, $T_J = -40\text{ to }125\text{ }^\circ\text{C}$ (AB), $T_J = 0\text{ to }125\text{ }^\circ\text{C}$ (AC) unless otherwise specified.

Symbol	Parameter	Test conditions	Min.	Typ.	Max.	Unit
V_O	Output voltage	$T_J = 25^\circ\text{C}$	9.8	10	10.2	V
V_O	Output voltage	$I_O = 5\text{ to }350\text{ mA}$, $V_I = 12.5\text{ to }25\text{ V}$	9.6	10	10.4	V
ΔV_O	Line regulation	$V_I = 12.5\text{ to }30\text{ V}$, $I_O = 200\text{ mA}$, $T_J = 25^\circ\text{C}$			100	mV
		$V_I = 13\text{ to }30\text{ V}$, $I_O = 200\text{ mA}$, $T_J = 25^\circ\text{C}$			30	
ΔV_O	Load regulation	$I_O = 5\text{ to }500\text{ mA}$, $T_J = 25^\circ\text{C}$			200	mV
		$I_O = 5\text{ to }200\text{ mA}$, $T_J = 25^\circ\text{C}$			100	
I_d	Quiescent current	$T_J = 25^\circ\text{C}$			6	mA
ΔI_d	Quiescent current change	$I_O = 5\text{ to }350\text{ mA}$			0.5	mA
		$I_O = 200\text{ mA}$, $V_I = 12.5\text{ to }30\text{ V}$			0.8	
$\Delta V_O/\Delta T$	Output voltage drift	$I_O = 5\text{ mA}$		-0.5		mV/ $^\circ\text{C}$
SVR	Supply voltage rejection	$V_I = 13.5\text{ to }24\text{ V}$, $f = 120\text{ Hz}$, $I_O = 300\text{ mA}$, $T_J = 25^\circ\text{C}$	56			dB
eN	Output noise voltage	$B = 10\text{ Hz to }100\text{ kHz}$, $T_J = 25^\circ\text{C}$		64		μV
V_d	Dropout voltage	$T_J = 25^\circ\text{C}$		2		V
I_{sc}	Short circuit current	$V_I = 35\text{ V}$, $T_J = 25^\circ\text{C}$		245		mA
I_{scp}	Short circuit peak current	$T_J = 25^\circ\text{C}$		700		mA

Table 9. Electrical characteristics of 78M12

Refer to the test circuits, $V_I = 19\text{ V}$, $I_O = 350\text{ mA}$, $C_I = 0.33\text{ }\mu\text{F}$, $C_O = 0.1\text{ }\mu\text{F}$, $T_J = -40\text{ to }125\text{ }^\circ\text{C}$ (AB), $T_J = 0\text{ to }125\text{ }^\circ\text{C}$ (AC) unless otherwise specified.

Symbol	Parameter	Test conditions	Min.	Typ.	Max.	Unit
V_O	Output voltage	$T_J = 25^\circ\text{C}$	11.75	12	12.25	V
V_O	Output voltage	$I_O = 5\text{ to }350\text{ mA}$, $V_I = 14.5\text{ to }27\text{ V}$	11.5	12	12.5	V
ΔV_O	Line regulation	$V_I = 14.5\text{ to }30\text{ V}$, $I_O = 200\text{ mA}$, $T_J = 25^\circ\text{C}$			100	mV
		$V_I = 16\text{ to }30\text{ V}$, $I_O = 200\text{ mA}$, $T_J = 25^\circ\text{C}$			30	
ΔV_O	Load regulation	$I_O = 5\text{ to }500\text{ mA}$, $T_J = 25^\circ\text{C}$			240	mV
		$I_O = 5\text{ to }200\text{ mA}$, $T_J = 25^\circ\text{C}$			120	
I_d	Quiescent current	$T_J = 25^\circ\text{C}$			6	mA
ΔI_d	Quiescent current change	$I_O = 5\text{ to }350\text{ mA}$			0.5	mA
		$I_O = 200\text{ mA}$, $V_I = 14.5\text{ to }30\text{ V}$			0.8	
$\Delta V_O/\Delta T$	Output voltage drift	$I_O = 5\text{ mA}$		-1		mV/ $^\circ\text{C}$
SVR	Supply voltage rejection	$V_I = 15\text{ to }25\text{ V}$, $f = 120\text{ Hz}$, $I_O = 300\text{ mA}$, $T_J = 25^\circ\text{C}$	55			dB
eN	Output noise voltage	$B = 10\text{ Hz to }100\text{ kHz}$, $T_J = 25^\circ\text{C}$		75		μV
V_d	Dropout voltage	$T_J = 25^\circ\text{C}$		2		V
I_{sc}	Short circuit current	$V_I = 35\text{ V}$, $T_J = 25^\circ\text{C}$		240		mA
I_{scp}	Short circuit peak current	$T_J = 25^\circ\text{C}$		700		mA

Table 10. Electrical characteristics of 78M15

Refer to the test circuits, $V_I = 23\text{ V}$, $I_O = 350\text{ mA}$, $C_I = 0.33\text{ }\mu\text{F}$, $C_O = 0.1\text{ }\mu\text{F}$,
 $T_J = -40\text{ to }125\text{ }^\circ\text{C}$ (AB), $T_J = 0\text{ to }125\text{ }^\circ\text{C}$ (AC) unless otherwise specified.

Symbol	Parameter	Test conditions	Min.	Typ.	Max.	Unit
V_O	Output voltage	$T_J = 25^\circ\text{C}$	14.7	15	15.3	V
V_O	Output voltage	$I_O = 5\text{ to }350\text{ mA}$, $V_I = 17.5\text{ to }30\text{ V}$	14.4	15	15.6	V
ΔV_O	Line regulation	$V_I = 17.5\text{ to }30\text{ V}$, $I_O = 200\text{ mA}$, $T_J = 25^\circ\text{C}$			100	mV
		$V_I = 20\text{ to }30\text{ V}$, $I_O = 200\text{ mA}$, $T_J = 25^\circ\text{C}$			30	
ΔV_O	Load regulation	$I_O = 5\text{ to }500\text{ mA}$, $T_J = 25^\circ\text{C}$			300	mV
		$I_O = 5\text{ to }200\text{ mA}$, $T_J = 25^\circ\text{C}$			150	
I_d	Quiescent current	$T_J = 25^\circ\text{C}$			6	mA
ΔI_d	Quiescent current change	$I_O = 5\text{ to }350\text{ mA}$			0.5	mA
		$I_O = 200\text{ mA}$, $V_I = 17.5\text{ to }30\text{ V}$			0.8	
$\Delta V_O/\Delta T$	Output voltage drift	$I_O = 5\text{ mA}$		-1		mV/ $^\circ\text{C}$
SVR	Supply voltage rejection	$V_I = 18.5\text{ to }28.5\text{ V}$, $f = 120\text{ Hz}$, $I_O = 300\text{ mA}$, $T_J = 25^\circ\text{C}$	54			dB
eN	Output noise voltage	$B = 10\text{ Hz to }100\text{ kHz}$, $T_J = 25^\circ\text{C}$		90		μV
V_d	Dropout voltage	$T_J = 25^\circ\text{C}$		2		V
I_{sc}	Short circuit current	$V_I = 35\text{ V}$, $T_J = 25^\circ\text{C}$		240		mA
I_{scp}	Short circuit peak current	$T_J = 25^\circ\text{C}$		700		mA

Table 11. Electrical characteristics of 78M24

Refer to the test circuits, $V_I = 33\text{ V}$, $I_O = 350\text{ mA}$, $C_I = 0.33\text{ }\mu\text{F}$, $C_O = 0.1\text{ }\mu\text{F}$,
 $T_J = -40\text{ to }125\text{ }^\circ\text{C}$ (AB), $T_J = 0\text{ to }125\text{ }^\circ\text{C}$ (AC) unless otherwise specified.

Symbol	Parameter	Test conditions	Min.	Typ.	Max.	Unit
V_O	Output voltage	$T_J = 25^\circ\text{C}$	23.5	24	24.5	V
V_O	Output voltage	$I_O = 5\text{ to }350\text{ mA}$, $V_I = 27\text{ to }38\text{ V}$	23	24	25	V
ΔV_O	Line regulation	$V_I = 27\text{ to }38\text{ V}$, $I_O = 200\text{ mA}$, $T_J = 25^\circ\text{C}$			100	mV
		$V_I = 28\text{ to }38\text{ V}$, $I_O = 200\text{ mA}$, $T_J = 25^\circ\text{C}$			30	
ΔV_O	Load regulation	$I_O = 5\text{ to }500\text{ mA}$, $T_J = 25^\circ\text{C}$			480	mV
		$I_O = 5\text{ to }200\text{ mA}$, $T_J = 25^\circ\text{C}$			240	
I_d	Quiescent current	$T_J = 25^\circ\text{C}$			6	mA
ΔI_d	Quiescent current change	$I_O = 5\text{ to }350\text{ mA}$			0.5	mA
		$I_O = 200\text{ mA}$, $V_I = 27\text{ to }38\text{ V}$			0.8	
$\Delta V_O/\Delta T$	Output voltage drift	$I_O = 5\text{ mA}$		-1.2		mV/ $^\circ\text{C}$
SVR	Supply voltage rejection	$V_I = 28\text{ to }38\text{ V}$, $f = 120\text{ Hz}$, $I_O = 300\text{ mA}$, $T_J = 25^\circ\text{C}$	50			dB
eN	Output noise voltage	$B = 10\text{ Hz to }100\text{ kHz}$, $T_J = 25^\circ\text{C}$		170		μV
V_d	Dropout voltage	$T_J = 25^\circ\text{C}$		2		V
I_{sc}	Short circuit current	$V_I = 35\text{ V}$, $T_J = 25^\circ\text{C}$		240		mA
I_{scp}	Short circuit peak current	$T_J = 25^\circ\text{C}$		700		mA

6 Typical performance

Figure 8. Dropout voltage vs. junction temp.

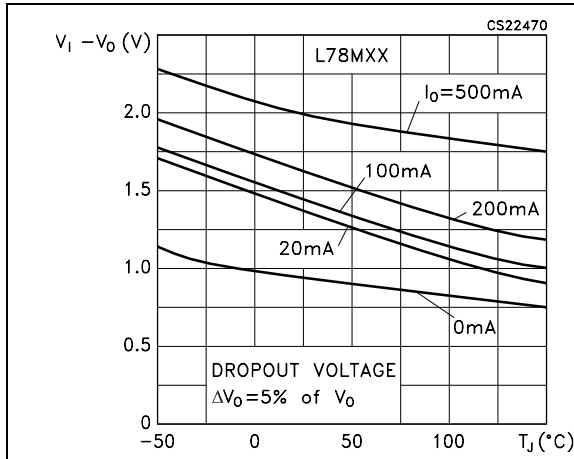

Figure 9. Dropout characteristics

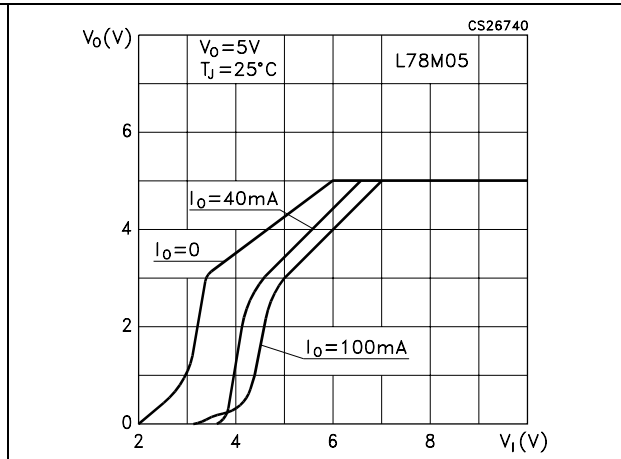

Figure 10. Peak output current vs. input-output differential voltage

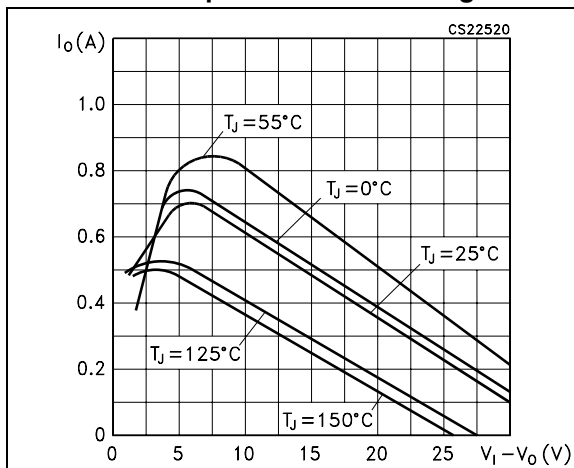

Figure 11. Output voltage vs. junction temperature

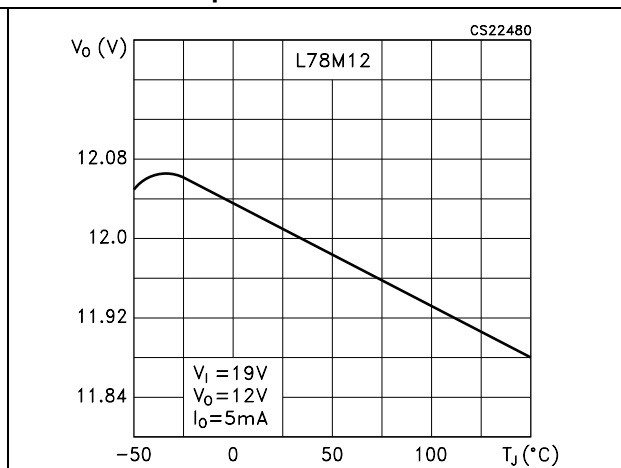

Figure 12. Supply voltage rejection vs. frequency

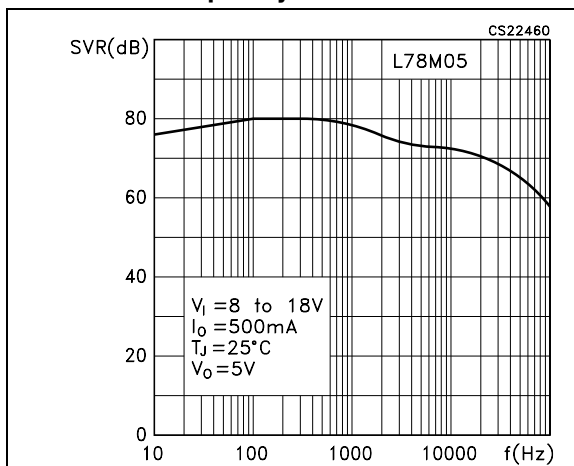

Figure 13. Quiescent current vs. junction temperature

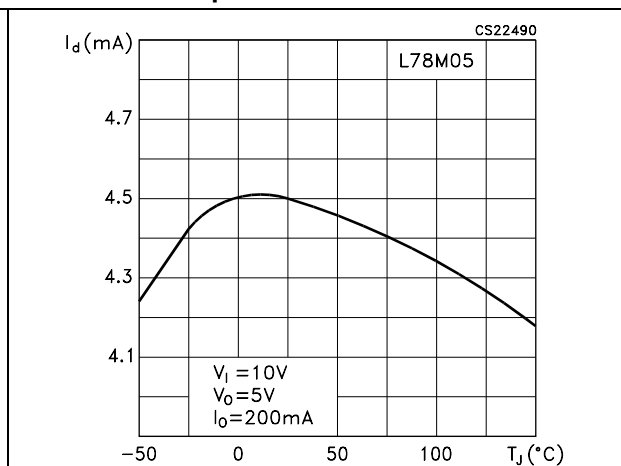

Figure 14. Load transient response

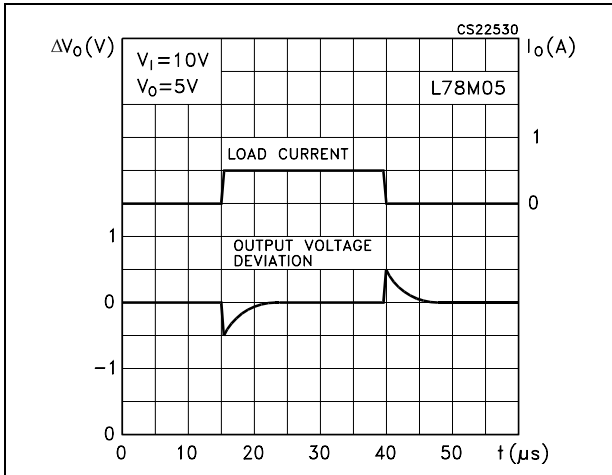

Figure 15. Line transient response

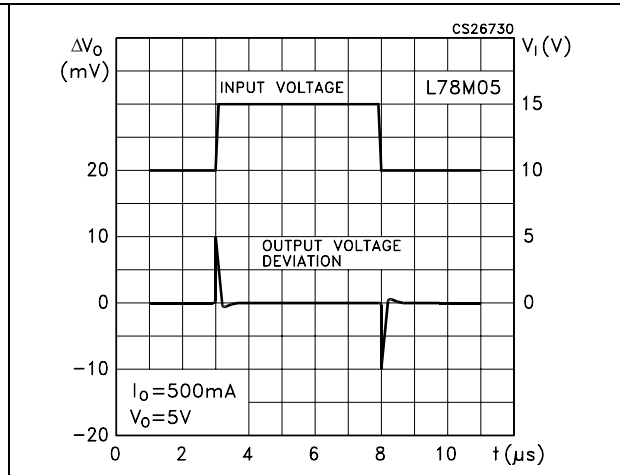

Figure 16. Quiescent current vs. input voltage

